

# AutoHoot™

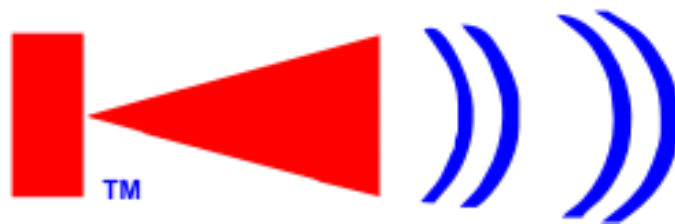

## AutoHoot Mk3 User Manual

---

## 1 CONTENTS

<b>1</b>	<b>CONTENTS.....</b>	<b>1</b>
<b>2</b>	<b>INTRODUCTION.....</b>	<b>3</b>
<b>3</b>	<b>DOCUMENT REVISION SUMMARY .....</b>	<b>3</b>
<b>4</b>	<b>TYPICAL AUTOHOOT SYSTEM.....</b>	<b>4</b>
<b>5</b>	<b>CONTROLS OVERVIEW.....</b>	<b>5</b>
<b>6</b>	<b>CONNECTION DIAGRAM .....</b>	<b>6</b>
<b>7</b>	<b>INSTALLATION.....</b>	<b>6</b>
7.1	Wiring Connections .....	6
7.2	Horn / Sounder .....	7
7.3	Power Supply .....	7
7.4	USB Configuration Cable .....	7
7.5	Installation.....	7
7.6	Additional Note on Wiring the AutoHoot.....	7
<b>8</b>	<b>CHANGING THE TIME AND SELECTING THE SEQUENCE.....</b>	<b>9</b>
8.1	Indication of Active Sequence .....	9
8.2	Time Display.....	9
8.3	Countdown Timer Display.....	9
8.4	Adjusting the time.....	10
8.5	Selecting the Active Sequence .....	11
8.6	Pre-programmed Sequences.....	11
8.7	Running a Sequence.....	13
<b>9</b>	<b>ADVANCED OPERATION.....</b>	<b>14</b>
9.1	To List all Sequences .....	17
9.2	To Select New Active Sequence .....	18
9.3	To Output a Sequence .....	19
9.4	To Program a Custom Sequence .....	20
9.5	AutoHoot Programme Instructions .....	22
9.6	SET Beeps Function.....	23
9.7	Outputting to the top line of the display .....	24
9.8	Settings Mode .....	25
9.9	AutoHoot Log .....	26
<b>10</b>	<b>BACKUP BATTERY WARNING .....</b>	<b>27</b>
<b>11</b>	<b>AUTOHOOT SPECIFICATION .....</b>	<b>28</b>

---

<b>APPENDICES .....</b>	<b>29</b>
A1 Guarantee .....	29
A2 WEEE (Waste, Electrical and Electronic Equipment) Statement.....	30
A3 RoHS Statement.....	30

## 2 INTRODUCTION

Thank you for choosing AutoHoot Mk3.

AutoHoot is an electronic control unit which can be connected to a suitable horn or sounder to produce a sequence of sound signals with reliable timing removing unnecessary human error. Primary designed for the use in starting sailing races it's basic operation is simple and intuitive. During the starting sequence AutoHoot's display shows the countdown time to the start. It comes with a number of pre-programmed sequences, and it is possible for the user to write and add their own custom sequences.

It has been designed for simple operation when a particular sound signal sequence is required to be emitted. It is not envisaged that the user would switch frequently between the standard sequences, but this is possible to do. AutoHoot is supplied with over 30 standard sequences pre-programmed into the memory. It is also possible for the user to write and add custom sequences using a C-type USB data cable to a PC or tablet/smartphone with a serial terminal program or app.

In addition to providing a preprogrammed start sequence sound signals for recalls, postponements and for finishing boats can be made.

AutoHoot is fully programmable so it's use is not limited to just starting sailing races. It can be used for many other applications from signals for circuit training and other interval training sessions, foghorn signals and even an alarm clock.

## 3 Document revision summary

Issue	Date	Description
1	October 2024	Original document
2	October 2024	Corrections and added CR2032 Battery Warning

Our products are in continuous development and therefore specifications may be subject to change and design improvements may be implemented without prior notice. Please visit our web site [www.r-p-r.co.uk](http://www.r-p-r.co.uk) for the most up to date information on our products.

### Trademarks

The Richard Paul Russell Ltd name and logo, AutoHoot and AutoHoot logo are trademarks of Richard Paul Russell Ltd.

## 4 TYPICAL AUTOHOOT SYSTEM

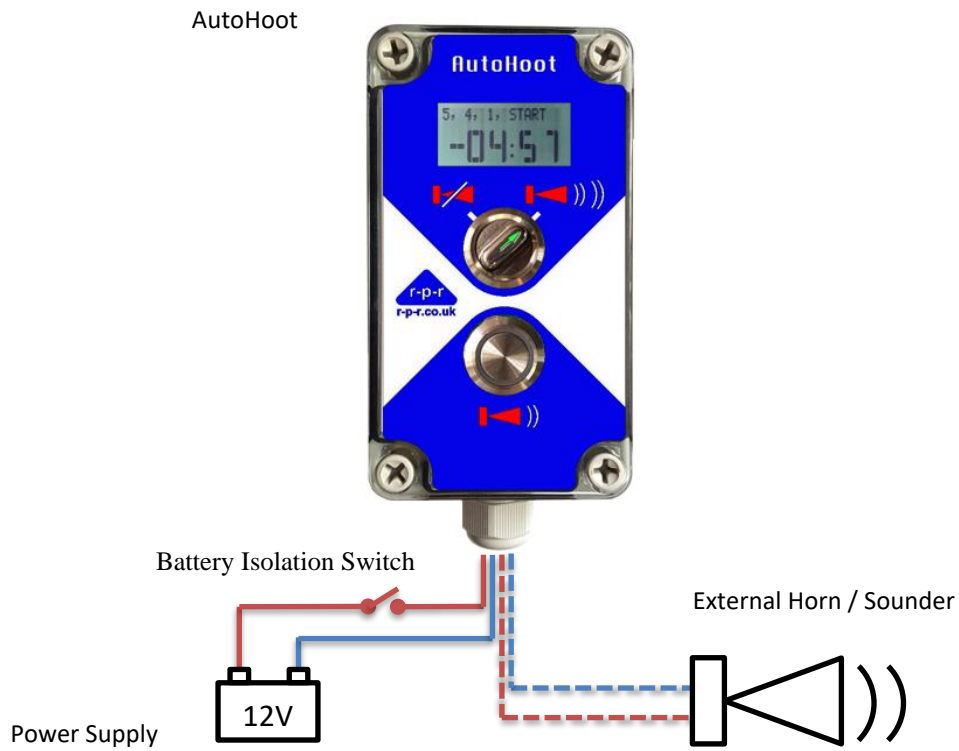

## 5 CONTROLS OVERVIEW

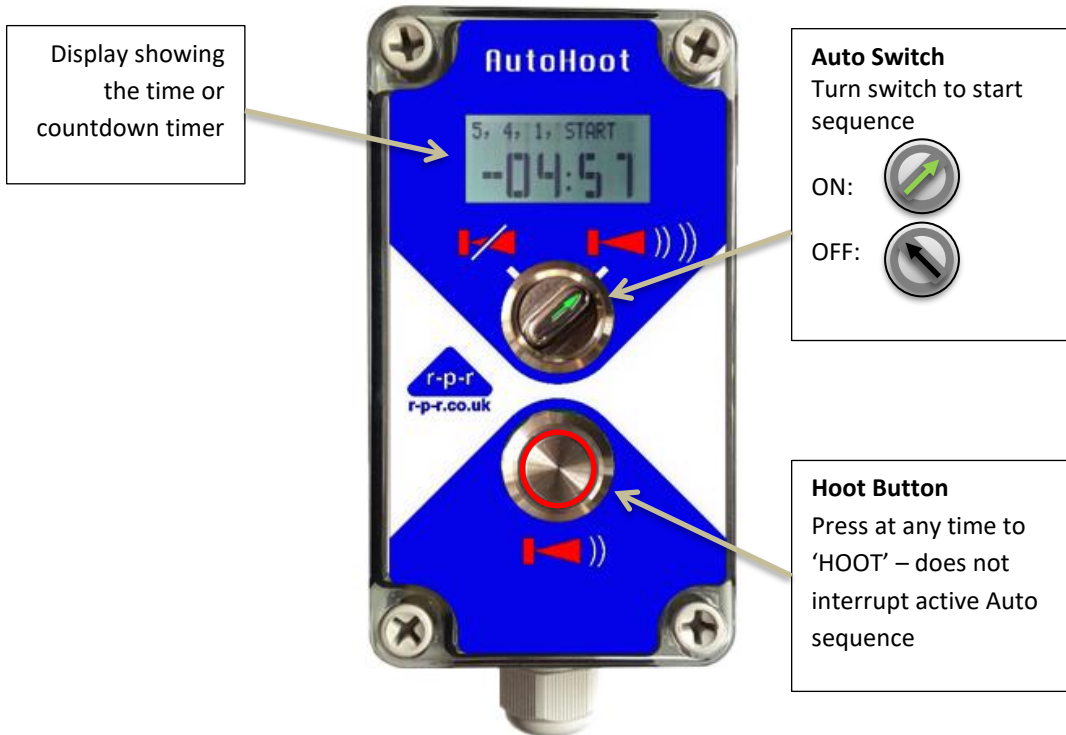

Figure 1

AutoHoot has been designed for simple operation and in practice when starting a race all that is required is to rotate the Auto switch in a clockwise direction at the start of the starting sequence. The Hoot button can be pressed at any time for other race signals like recalls, shorten course or finish signals.

## 6 CONNECTION DIAGRAM

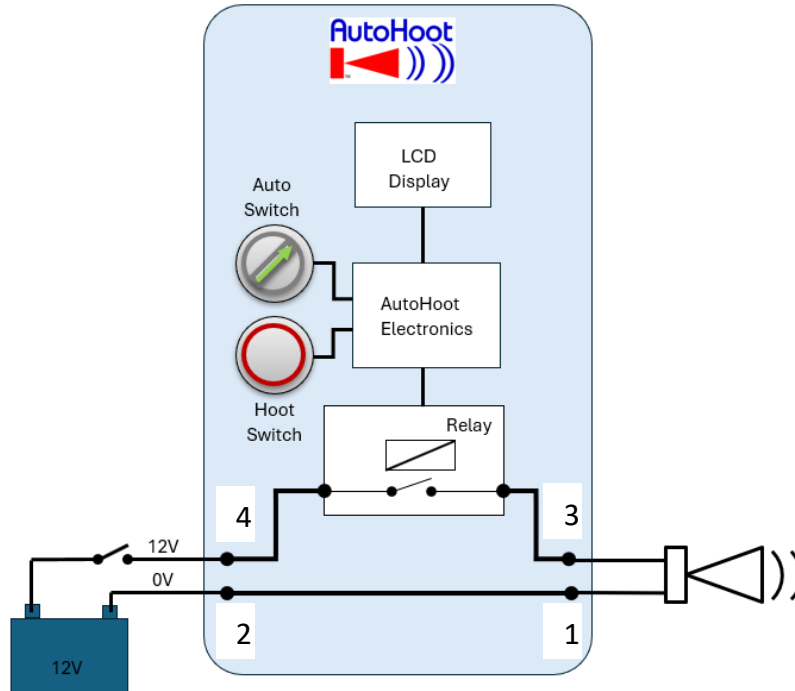

Figure 2

## 7 INSTALLATION

### 7.1 Wiring Connections

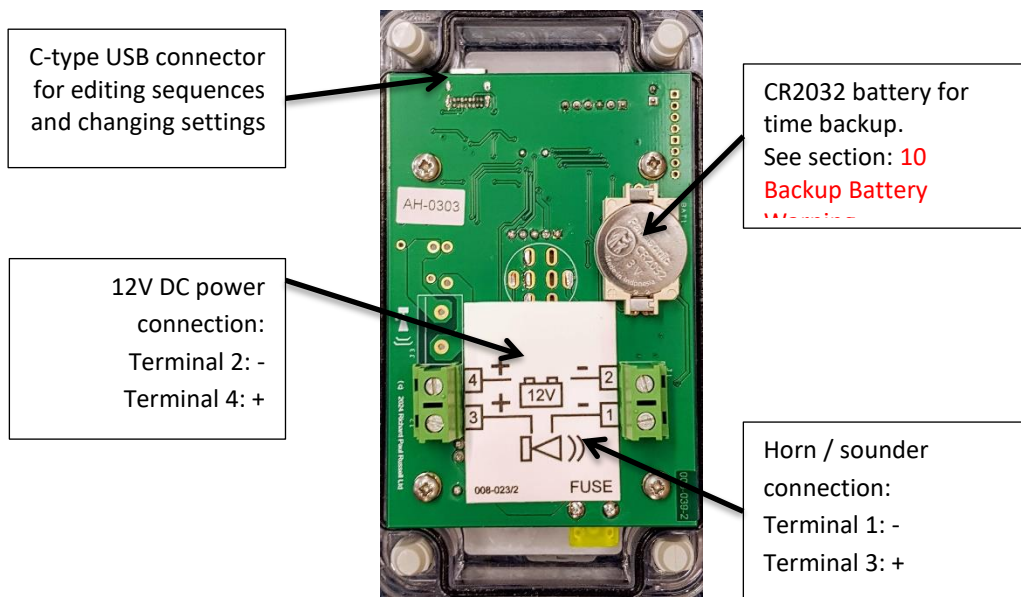

Figure 2

---

## 7.2 Horn / Sounder

A 12V horn or sounder needs to be connected to produce a high decibel output. The choice of horn or sounder will depend on the application.

For starting dinghy races on restricted water, the type of low-cost car horn that can be purchased from a local car accessory shop is suitable. For starting large fleet sailing races on open water, a large truck horn or marine horn would be better.

Car & marine horns can require high peak currents so long cable runs should be avoided. For indoor use, a fire alarm type sounder may produce sufficient decibels as a sound signal. The horn is connected via terminals 1 (-ve) and 3 (+ve) on the green connector blocks.

## 7.3 Power Supply

12V DC power is supplied via terminals 2 (-ve) and 4 (+ve) on the green connector blocks. The power supply needs to be capable of supplying sufficient current to the particular horn/sounder that is connected.

Typically, power will be supplied via a 12V car battery or the committee boat's main battery.

## 7.4 USB Configuration Cable

The AutoHoot may be operated with any of the standard pre-programmed sequences without connection to a PC. If other sequences are required, it is necessary to connect the AutoHoot to a PC/tablet/smart phone using a standard C-type USB cable.

## 7.5 Installation

Cable entry to the AutoHoot enclosure should be via the fitted cable gland. The cable gland is suitable for cable diameters 5 to 13mm. It includes 2 sizes of grommet; select the most appropriate for the cable size used. The cable gland should be tightened to ensure watertight integrity.

Cable connection is to rising clamp style terminals. If the wire used is multi-strand, ensure that all strands are inserted in the terminal hole.

Please note that interconnection of all components should be completed prior to applying power. When mounting the unit, it is best if the display is viewed from the 6 o'clock direction.

## 7.6 Additional Note on Wiring the AutoHoot

As the cables can carry high currents which could interfere with AutoHoot's electronics, the cable within the AutoHoot enclosure should not encroach on the area beyond the terminal blocks as in Figure A but should be arranged to be as in Figure B. If the AutoHoot is being used in a hand-held application a cable tie should be put round the cable to provide extra protection from the cable being pulled though the cable gland. Figure C shows the suggested lengths to strip the cable.



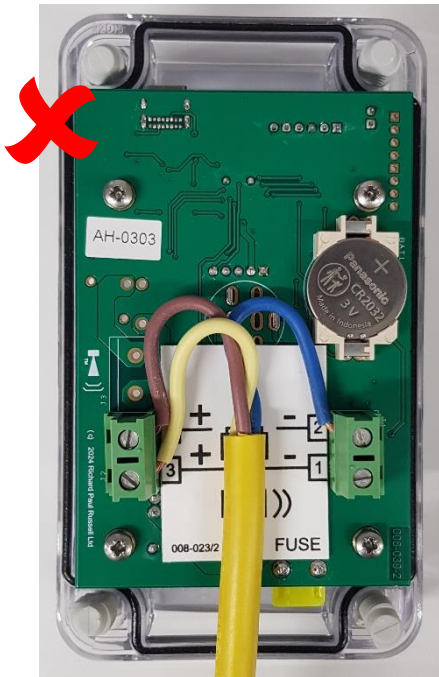

Figure A

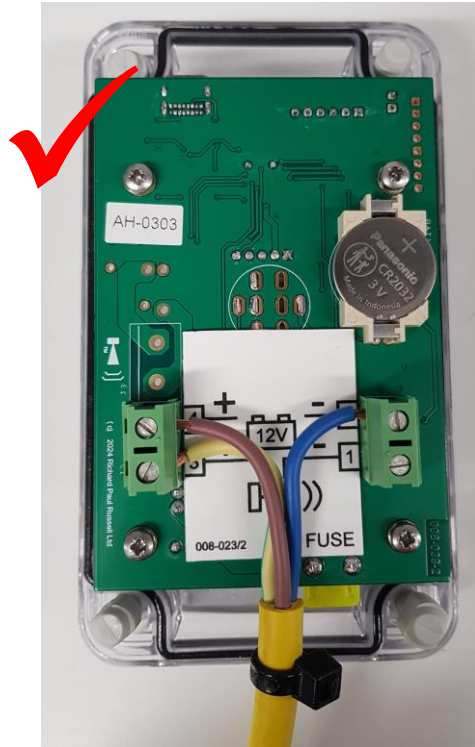

Figure B

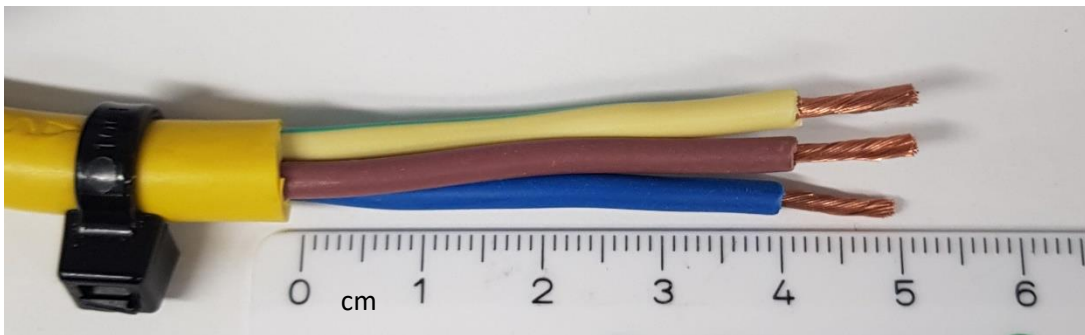

Figure C

Note: AutoHoot must be connected to a 6.5v to 15v DC power source.

## 8 CHANGING THE TIME AND SELECTING THE SEQUENCE

### 8.1 Indication of Active Sequence

On power up the display will show momentarily software version followed by the current the active sequence:

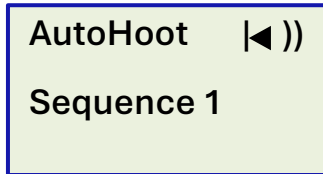

### 8.2 Time Display

When the Auto switch is in the off position AutoHoot displays time in 24 hours format with the hours in a smaller character size.



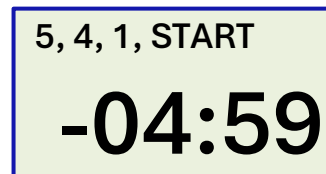

### 8.3 Countdown Timer Display

During a sequence a countdown/count up timer can be displayed. It is always displayed with a minus sign when in count down mode or a plus sign when in count up mode.



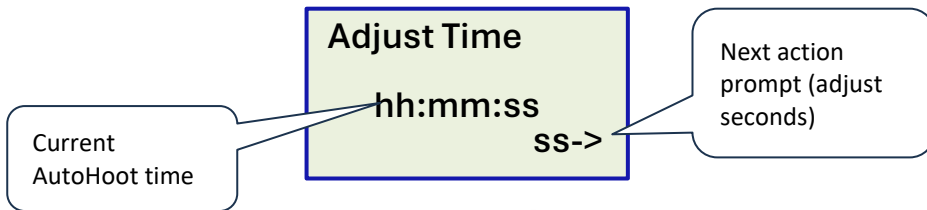

## 8.4 Adjusting the time

With power off and the Auto switch in the off position  hold the Hoot button  pressed. Switch on the power keeping the Hoot button pressed for about 4 seconds until the display shows:

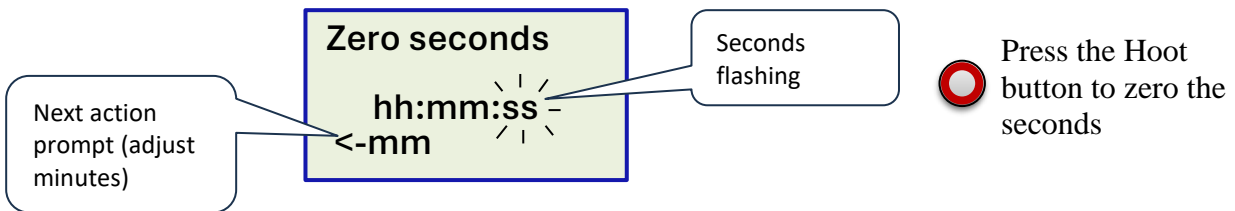

Rotate Auto Switch to the ON position  to adjust the seconds



Rotate Auto Switch to the OFF position  to adjust the minutes

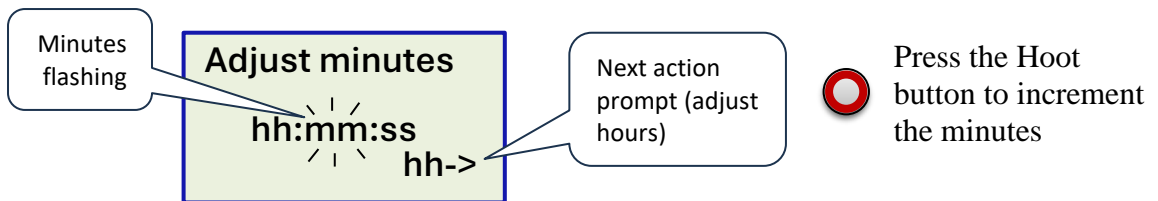

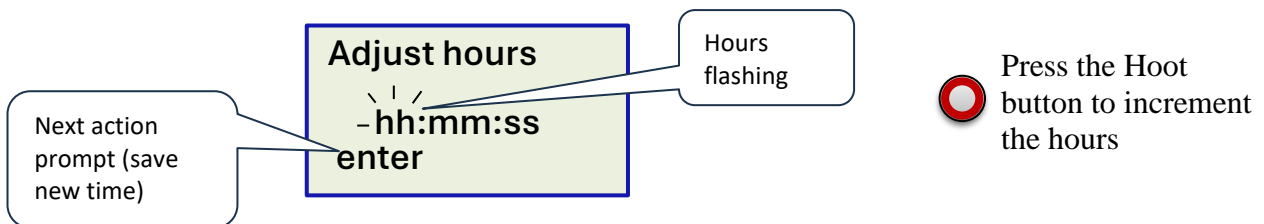

Rotate Auto Switch to the ON position  to adjust the hours



Rotate Auto Switch to the OFF position  to enter the new time and resume normal AutoHoot operation.

## 8.5 Selecting the Active Sequence

With power off and the Auto switch in the off position  hold the Hoot button  pressed. Switch on the power keeping the Hoot button pressed for about 15 seconds until the display shows Adjust Sequence with the current sequence in large digits:

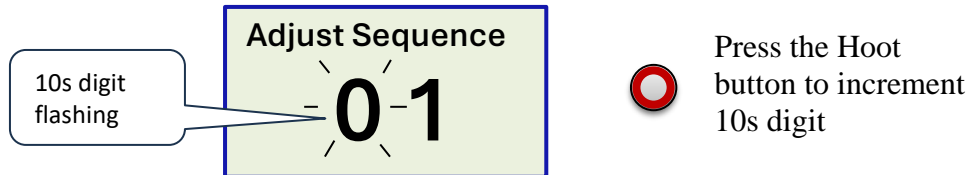

Rotate Auto Switch to the ON position  to adjust the units digit

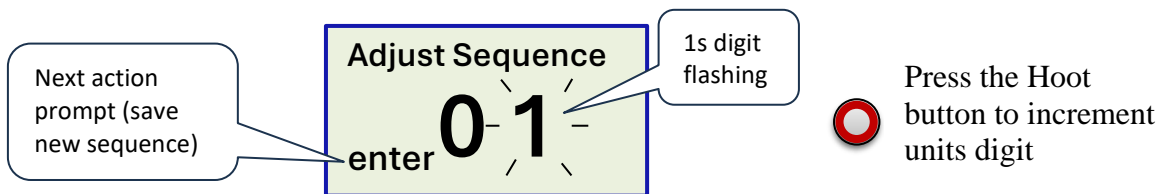

Rotate Auto Switch to the OFF position  to enter the new active sequence and resume normal AutoHoot operation.

Note: If the sequence selected does not exist, the active sequence will remain unchanged.  
 Note: If the selection process is not completed, the unit will time out 15 seconds after the last action. The active sequence will remain unchanged.

## 8.6 Pre-programmed Sequences

AutoHoot is pre-programmed with the following sequences. The default active sequence is no 1.

No	Name	Description
1	Rule 26 1.5s rep no delay	RRS Rule 26 (5,4,1,start) – 1.5 sec hoots with long hoot at 1 min to go, multiple starts at 5 min intervals, no delay before first signal
2	Rule 26 1.5s no delay	RRS Rule 26 (5,4,1,start) – 1.5 sec hoots with long hoot at 1 min to go, one start only, no delay before first signal
3	Rule 26 1.5s rep 10s delay	RRS Rule 26 (5,4,1,start) – 1.5 sec hoots with long hoot at 1 min to go, multiple starts at 5 min intervals, 10 sec delay before first signal
4	Rule 26 1.5s 10s delay	RRS Rule 26 (5,4,1,start) – 1.5 sec hoots with long hoot at 1 min to go, one start only, 10 sec delay before first signal
5	Rule 26 2.5s rep no delay	RRS Rule 26 (5,4,1,start) – 2.5 sec hoots with long hoot at 1 min to go, multiple starts at 5 min intervals, no delay before first signal
6	Rule 26 2.5s no delay	RRS Rule 26 (5,4,1,start) – 2.5 sec hoots with long hoot at 1 min to go, one start only, no delay before first signal
7	Rule 26 2.5s rep 10s delay	RRS Rule 26 (5,4,1,start) – 2.5 sec hoots with long hoot at 1 min to go, multiple starts at 5 min intervals, 10 sec delay before first signal
8	Rule 26 2.5s 10s delay	RRS Rule 26 (5,4,1,start) – 2.5 sec hoots with long hoot at 1 min to go, one start only, 10 sec delay before first signal
9	Rule 26 2.5s 10min rep no delay	RRS Rule 26 (5,4,1,start) – 2.5 sec hoots with long hoot at 1 min to go, multiple starts at 10 min intervals, no delay before first signal

No	Name	Description
10	Rule 26 2.5s 10min rep 10s delay	RRS Rule 26 (5,4,1,start) – 2.5 sec hoots with long hoot at 1 min to go, multiple starts at 10 min intervals, 10 sec delay before first signal
11	3,2,1(long),0 rep no delay	3,2,1,start with long hoot at 1 min – multiple starts at 3 min intervals, no delay before first signal
12	3,2,1(long),0 no delay	3,2,1,start with long hoot at 1 min – one start only, no delay before first signal
13	3,2,1(long),0 rep 10s delay	3,2,1,start with long hoot at 1 min – multiple starts at 3 min intervals, 10 sec delay before first signal
14	3,2,1(long),0 10s delay	3,2,1,start with long hoot at 1 min – one start only, 10 sec delay before first signal
15	5 min hoots	1 signal every 5 min
16	4 min hoots	1 signal every 4 min
17	3 min hoots	1 signal every 3 min
18	2 min hoots	1 signal every 2 min
19	1 min hoots	1 signal every 1 min
20	5 min count-down	5 min count-down to start – 5 long hoots at 5 min, 4 at 4 min, 3 at 3 min, 2 at 2 min, 1 long & 3 short at 1 min 30 sec, 1 long at 1 min, 3 short at 30 sec, 2 short at 20, 1 short at 10 & 5,4,3,2 & 1 sec & 1 long at start, one start only
22	3 min count-down (Appx S)	US Sailing RRS Appendix S Sound-Signal Starting System (includes 3 long hoots at 3 min, 2 at 2 min, 1 long & 3 short at 1 min 30 sec, 1 long at 1 min, 3 short at 30 sec, 2 short at 20, 1 short at 10 & 5,4,3,2,1 sec & 1 long at start, one start only)
23		
24	1 min count-down	1 min count-down to start – 1 long hoot at 1 min, 3 short at 30 sec, 2 short at 20, 1 short at 10 & 5,4,3,2 & 1 sec & 1 long at start, one start only
26	3 min team race	Team Racing Start – 3 long hoots at 3 min, 2 at 2 min, 1 at 1 min, 3 short at 30 sec, 2 short at 20, 1 short at 10 & 5,4,3,2,1 sec & 1 long at start, one start only
27	3 min team race rep.	As per No.26 but with multiple starts at 3min 30s intervals
28	3 min team race rep 4min	As per No.26 but with multiple starts at 4 min intervals
29	3 min team race rep 5min	As per No.26 but with multiple starts at 5 min intervals
30	3 min team race rep 6min	As per No.26 but with multiple starts at 6 min intervals
31	7min match race 5 min rep	RRS Appendix C 3.1 Match Racing Starting Signals with ‘Attention signal’ at 7 min before first start, start signal is the warning for next flight (i.e. starts at 5 min intervals)
32	Olympic start sequence	2024 Olympic SI 12.4.1
33	Olympic medal race sequence	2024 Olympic SI 12.4.2
34	App B3 reaching starts	RRS Appx B3 Windsurfing reaching starts. 3min no sound, 2min warning, 1min preparatory, 30sec no sound, start
36	fog horn powered underway	ColRegs - Signals in Restricted Visibility - Power-Driven Vessels Underway – 1 prolonged blast every 1 min
37	Fog horn sailing	ColRegs - Signals in Restricted Visibility - Sailing Vessels Underway – 1 prolonged blast followed by two short blasts every 1 min
38	Radio Sailing E3.4(a) rep 2min	RRS Appx E3.4(a) Multiple starts at 2 min intervals
39	Radio Sailing E3.4(a) rep 3min	RRS Appx E3.4(a) Multiple starts at 3 min intervals
40	Alarm Clock 7am	One hoot at 7am

As new sequences are requested or developed this list is subject to change. AutoHoot Mk3 is fully programmable, and the user can add or amend sequences as required.

## 8.7 Running a Sequence

To start the selected sequence running, rotate the Auto Switch to the ON position. The green LED will turn on:



Auto Switch in ON position

When the sequence has completed, or in the case of a continuously repeating sequence has run sufficient cycles, rotate the Auto Switch to the OFF position.

At any stage it is required to abandon the active sequence (e.g. after a sailing race general recall or postponement) the sequence may be terminated by rotating the Auto Switch to OFF position.

**Note:** It is not possible to pause the active sequence; when the Auto Switch is subsequently rotated to the ON position, the sequence will re-start from the beginning.

If at any time, an additional sound signal is required (e.g. on a sailing race individual or general recall or when finishing a competitor) pressing the Hoot Button will produce a sound signal for the duration the Hoot Button is held down.



Hoot Button – press & hold for additional sound signal

Using the Hoot Button does not interrupt any sequence that is currently running.

## 9 ADVANCED OPERATION

AutoHoot is supplied pre-programmed with a number of standard sequences but if one of these does not fulfil the requirements of an application, any possible combination of sound signals may be programmed by the user. For this 'advanced' operation, a C-Type USB Cable is required. Power to AutoHoot can be supplied from the computer's USB port for programming and setup but to operate the relay and horn the 12v supply is required.

Connection of AutoHoot to a PC running terminal emulation software, such as HyperTerminal, via the USB cable enables the following advanced features to be accessed:

- Output list of all programmed sequences
- Output details of each programmed sequence
- Programme custom sequences
- Adjust settings – current sequence, time, led brightness
- Output a log giving the times of up to the last 300 hoots

Since Microsoft no longer includes HyperTerminal with Windows software. If your PC does not have HyperTerminal installed, you may download HyperTerminal from the internet, or use alternative free software, for example PUTTY.

It is also possible to use an Android smart phone or tablet with the app 'Serial USB Terminal' from the Google Play store.

The instructions below refer to HyperTerminal but can be adapted for other terminal emulation software.

### To Set Up Communication between AutoHoot and a PC

1. Switch off power to the AutoHoot.
2. Unscrew AutoHoot enclosure to access the PCB.
3. Plug a C-type USB cable into AutoHoot.
4. Plug the other end of the USB cable into a USB port on the PC.
5. On your PC, go to CONTROL PANEL then VIEW DEVICES AND PRINTERS.
6. Find device 'FT230X Basic UART'
7. Right click to display PROPERTIES

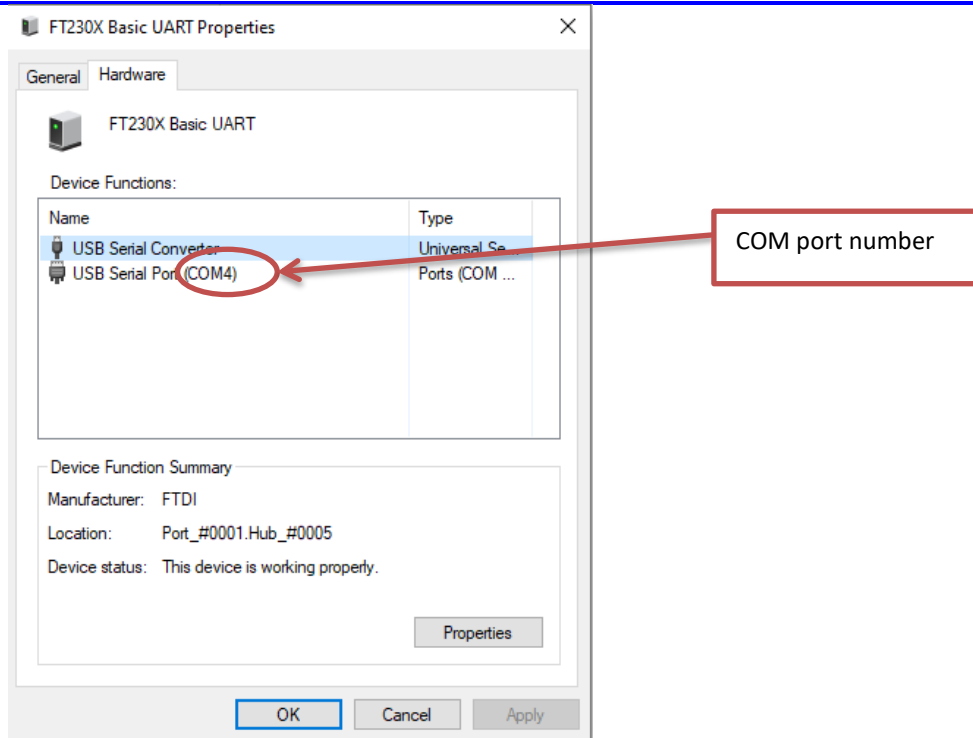

8. Under the HARDWARE tab, take note of the USB serial COM port number. E.g. COM4 above
9. Open HyperTerminal (or other terminal emulation software)
10. You may give the connection a name, e.g. AutoHoot.
11. Select to connect using the correct COM port as identified above, e.g. COM4

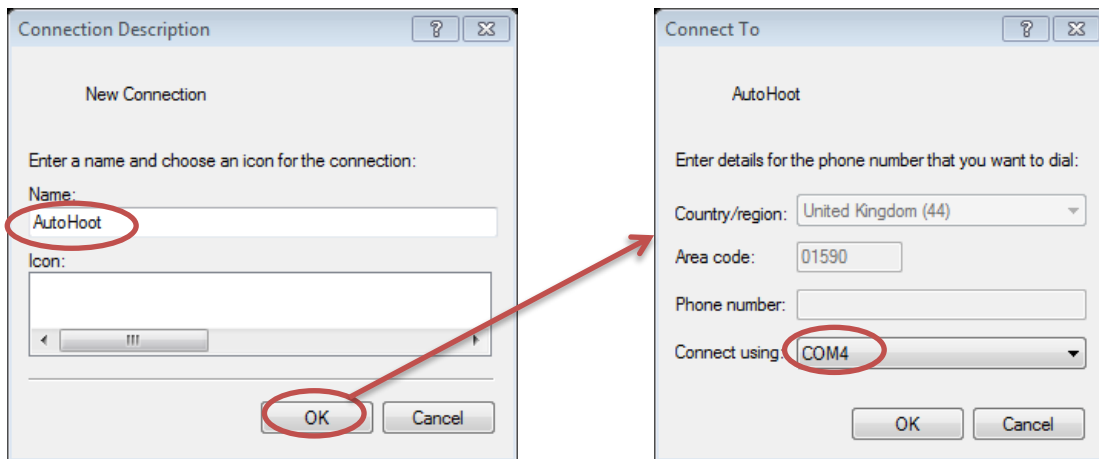

12. Set up of the connection must be as follows:

- 9600 bits per second
- 8 data bits
- No parity
- 1 Stop bit
- Hardware



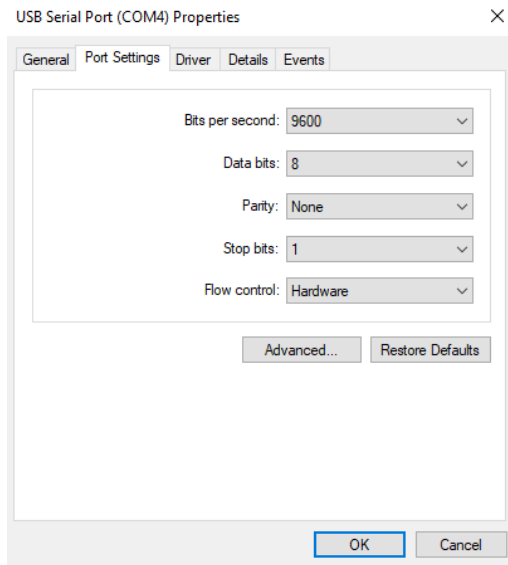

13. Click OK to save the settings

14. Press ENTER on your PC keypad and the following AutoHoot menu will be output:

```
->
1 - select sequence
2 - enter sequence
3 - delete sequence
4 - copy sequence
5 - output sequence
6 - list all sequences
7 - settings mode
8 - output log
->
```

## 9.1 To List all Sequences

At the User Prompt (->) type '6' to list all sequences

- All available sequences are listed in numerical order
- The active (selected) sequence is highlighted by an asterisk \*
- At the end of the list the amount of program memory used is indicated by 'X% used'

```
-> 6
No.      Name
*1  "Rule 26 1.5s rep no delay"
2  "Rule 26 1.5s no delay"
3  "Rule 26 1.5s rep 10s delay"
4  "Rule 26 1.5s 10s delay"
5  "Rule 26 2.5s rep no delay"
6  "Rule 26 2.5s no delay"
7  "Rule 26 2.5s rep 10s delay"
8  "Rule 26 2.5s 10s delay"
9  "Rule 26 2.5s 10min rep no delay"
10 "Rule 26 2.5s 10min rep 10s delay"
11 "3,2,1(long),0 rep no delay"
12 "3,2,1(long),0 no delay"
13 "3,2,1(long),0 rep 10s delay"
14 "3,2,1(long),0 10s delay"
15 "5 min hoots"
16 "4 min hoots"
17 "3 min hoots"
18 "2 min hoots"
19 "1 min hoots"
20 "5 min count-down"
22 "3 min count-down (Appx S)"
24 "1 min count-down"
26 "3 min team race"
27 "3 min team race rep 3:30"
28 "3 min team race rep 4min"
29 "3 min team race rep 5min"
30 "3 min team race rep 6min"
31 "7min match race, 5 min rep"
32 "Olympic start sequence"
33 "Olympic medal race sequence"
34 "App B3 reaching starts"
36 "fog horn powered underway"
37 "fog horn sailing"
38 "Radio Sailing E3.4(a) rep 2min"
39 "Radio Sailing E3.4(a) rep 3min"
40 "Alarm Clock 7am"

65% used
```

Note the actual sequences programmed into AutoHoot may be different to the list above.

## 9.2 To Select New Active Sequence

At the User Prompt (->) type '1' to select a different sequence to be active.

When prompted by 'sequence number?' type the number of the sequence to become active.

```
->1 - select sequence
sequence number? 2
sequence number = 2
->
```

If then '6' is typed again, to list all sequences, the asterisk will now indicate the newly selected sequence as active.

```
->1 - select sequence
sequence number? 2
sequence number = 2
->6

No.      Name
1  "Rule 26 1.5s rep no delay"
*2  "Rule 26 1.5s no delay"
3  "Rule 26 1.5s rep 10s delay"
4  "Rule 26 1.5s 10s delay"
5  "Rule 26 2.5s rep no delay"
```

**Note:** If the sequence number entered is not available an error message will be displayed; the active sequence will remain unchanged.

**Note:** Pressing ESC will exit the command.

## 9.3 To Output a Sequence

At the User Prompt (->) type '5' to output a sequence.

When prompted by 'sequence number?' type the number of the sequence to be displayed. The full sequence will then be output.

```
->5 - output sequence
sequence number? 1

1 SEQUENCE = 1
2 NAME = "Rule 26 1.5s rep no delay"
3 SET HootLength = 1.5
4 DISPLAY = "5, 4, 1, START  "
5 TIMER =-00:05:00
6 DELAY 00:00.0
7 HOOT
8 DELAY 01:00.0
9 HOOT
10 SET HootLength = 3.0
11 DELAY 03:00.0
12 HOOT
13 SET HootLength = 1.5
14 DELAY 01:00.0
15 HOOT
16 SEND = "START \@ "
17 TIMER =-00:05:00
18 GOTO 8
19 END

->
```

If required the sequence can then be copied and pasted into notepad for editing.

## 9.4 To Program a Custom Sequence

Each sequence requires a name and a number. Sequences are stored in AutoHoot in terms of actions and delays between actions.

1. At the User Prompt (->) type '2' to enter sequence
2. At prompt 'sequence number?' type the number for the new sequence (between 1 and 255). Note that sequences 100 and above cannot be selected manually using the switch procedure on power up.
3. At prompt 'sequence name?' type the name by which the sequence will be recognised (up to 32 characters)

```
->2 - enter sequence
sequence number? 41
sequence name? Demo Start

? - instruction help
L - list
END - exit

1 SEQUENCE = 41
2 NAME = "Demo Start"
-> 3
```

4. Starting from line 3, with one instruction per line, the sequence instructions may then be typed in. Sequences are stored in AutoHoot in terms of actions and delays between actions. A number of parameters, such as the length of the sound signal, may be set.
5. It is recommended that new sequences are drafted in Notepad or other text editor and copied into HyperTerminal using the 'Edit' – 'Paste to host' function. More than one line or even the whole sequence may be copied at a time.
6. Whilst in editing mode, typing '?' after the User Prompt lists all available instructions that may be used to program the AutoHoot:

```
1 SEQUENCE = 41
2 NAME = "Demo Start"
-> 3 ?
instructions
AT = hh:mm:ss
DELAY = m:s.s
DISPLAY = "text"
END
GOSEQUENCE n
GOTO n or @+-n
HOOT
JUMPNZ n or @+-n
NAME = "text"
SEND = "text"
SEQUENCE = n
SET Beeps = s
SET Count = n
SET HootLength = s.s
SUBSEQUENCE n
TIMER = -hh:mm:ss
-> 3
```

7. At any time after the User Prompt typing 'L' lists the sequence code currently being edited up to the current line:

```
-> 6 L
1 SEQUENCE = 41
2 NAME = "Demo Start"
3 HOOT
4 DELAY 01:00.0
5 HOOT
-> 6
```

8. At any time whilst inputting a sequence it is possible to make a change to an earlier instruction line if needed. This is done by pre-fixing the current instruction line with the line number of the line to change. This new line will overwrite the original line of the same number and all subsequent lines entered. Entry of instructions will continue from the edited line.

```
1 SEQUENCE = 41
2 NAME = "Demo Start"
3 HOOT
4 DELAY 01:00.0
5 HOOT
-> 6 3 SET HootLength = 2.5
3 SET HootLength = 2.5
-> 4 HOOT
4 HOOT
-> 5
```

9. When the list of instructions is complete, instruction END must be used to exit the sequence. There is a user prompt 'save sequence? Y/N' before the new sequence is saved.
10. Once the END instruction is input the sequence may not be edited (only deleted in whole).

```
1 SEQUENCE = 41
2 NAME = "Demo Start"
3 SET HootLength = 2.5
-> 4 HOOT
4 HOOT
-> 5 DELAY = 01:00
5 DELAY 01:00.0
-> 6 HOOT
6 HOOT
-> 7 END
7 END
save sequence? Y

sequence saved
->
```

Note: The maximum number of lines per sequence is approx. 200.

Note: A sequence may be deleted by selecting '3' from the AutoHoot menu. It is possible to delete the standard pre-programmed sequences.

## 9.5 AutoHoot Programme Instructions

AutoHoot is programmed using a combination of the following instructions:

Instruction	Description	Valid Parameters	Example	Default value
AT	Wait till the given time before executing any further instructions	hh:mm:ss	AT=07:00:00	
DELAY	Time delay before next instruction is implemented, in minutes (m) and seconds (s) to the nearest 0.1 sec	mm:ss.s	DELAY = 01:30.0 (delay for 1 min 30 sec)	-
DISPLAY	Display text on the top line of the display. A number of special characters and the time may be incorporated see section 9.7	Up to 16 characters	DISPLAY="My Sequence 1 "	
END	End of the sequence – always required as final line. Use to exit program editing.	-	END	-
GOSEQUENCE	Jump to another sequence. Can be used to join sequences together. Will not return to original sequence.	Sequence number (between 1 and 255)	GOSEQUENCE 2 (will leave current sequence to run sequence 2)	-
GOTO	Jump to defined line in the code or jump forward or back by certain number of lines (when @ used). Useful when a sequence is required to repeat indefinitely.	Line number or @ Line difference	GOTO 5 (will jump to line 5 of sequence) GOTO @-5 (will jump back 5 lines of sequence)	-
HOOT	Output sound signal. Length of HOOT is pre-set using SET HootLength.	-	HOOT	-
JUMPNZ	Use at the end of part of a sequence that is to repeat. JUMPNZ decrements the Count by 1 and if the Count is then not zero jumps to the defined line in the code or jumps forward or back by certain number of lines (when @ used).	Line number or @ Line difference	JUMPNZ 5 (will jump to line 5 of sequence) JUMPNZ @+5 (will jump forward 5 lines of sequence)	-
NAME	Name of the sequence	Up to 32 characters (including spaces)	NAME = "My Sequence"	
SEND	Outputs a message to the USB Configuration Cable.	Up to 100 characters (including spaces)	SEND = "My text message"	
SEQUENCE	Number of the sequence. Must be the first line of a sequence.	Sequence number (between 1 and 255)	SEQUENCE = 10	-
SET Beeps	Defines time, to nearest second, for which a series of short sound signals is output by the AutoHoot internal buzzer, before the end of a DELAY. See below for details.	s (between 0 and 120 seconds)	SET Beeps = 40 (Beep series will run in the last 40 seconds before the end of the current DELAY period)	5
SET Count	Defines total number of loops for part of a sequence to repeat. To be used with JUMPNZ.	c	SET Count = 3 (Subsequence loop will run repeat 3 times)	-
SET HootLength	Defines length of subsequent HOOTS output, in seconds to the nearest 0.1 sec. HootLength remains at this value until next SET HootLength instruction.	s.s (between 0.1 and 255 seconds)	SET HootLength = 4.5 (subsequent HOOTS will have 4.5 sec duration)	1.5
SUBSEQUENCE	Enables another sequence to be used as part of current sequence. Will return to next line of original sequence.	Sequence number (between 1 and 255)	SUBSEQUENCE = 100	-
TIMER	Displays the countdown/count up timer when	-hh:mm:ss	TIMER=-00:05:00	

	a time is specified. When the time is preceded by a minus sign the timer will count down to zero and then count up. If no time is specified, the timer will be removed from the display and the time displayed.	hh:mm:ss	(count down from 5 minutes) TIMER=00:00:00 (count up from zero) TIMER (remove TIMER from display)	
?	Help – lists prompts for valid instructions	-	?	-
L	Lists the sequence code currently being edited	-	L	-

## 9.6 SET Beeps Function

A series of warning Beeps may be output by the AutoHoot internal buzzer before the end of a DELAY. The time at which this Beep series starts before the end of the DELAY is defined by SET Beeps (in seconds).

The full series of Beeps that may be output is as follows:

Time before end of DELAY	Warning Beep Signal
2 min	2 long
1 min	1 long
30 sec	3 short
20 sec	2 short
10 sec	1 short
5 sec	1 short
4 sec	1 short
3 sec	1 short
2 sec	1 short
1 sec	1 short
0 sec	Beep equal in duration to HootLength

The proportion of the Beep series that is used will depend on the number of seconds set by SET Beeps. It is also limited by the DELAY. For example, if SET Beeps = 40 and DELAY = 02:00, the Beeps will commence 30 secs to go before end of the delay with 3 short Beeps followed by 2 short at 20 sec to go etc. If the SET Beeps = 40 and DELAY = 00:15, the Beeps will just start with 10 sec to go before the end of the delay.

If a warning Beep is required when the sequence is first started or an individual Beep is useful at any stage during the sequence, an additional instruction line of DELAY = 0 may be inserted. Beeps may be switched off by using instruction SET Beeps with no value, i.e. "SET Beeps =".



## 9.7 Outputting to the top line of the display

The DISPLAY instruction is used to output to the top line of the display. Up to 16 characters can be displayed including several special characters and the time.

Figure 4 shows the available lcd characters. If a non-standard character is required, then it can be specified by \hh where hh is the hexadecimal value of the character given in Figure x. For example, if an up arrow is required this would be \DE or if a down arrow was required this would be \E0

b3-0 b7-4	0	1	2	3	4	5	6	7	8	9	A	B	C	D	E	F
00																
10	▶	◀	⬆	⬇	⬈	⬉	⬊	⬋	⬌	⬍	⬎	⬏	⬐	⬑	⬒	■
20	!	"	#	%	&	'	(	)	*	+	,	-	.	/		
30	0	1	2	3	4	5	6	7	8	9	:	:	<	=	>	?
40	i	A	B	C	D	E	F	G	H	I	J	K	L	M	N	O
50	P	Q	R	S	T	U	V	W	X	Y	Z	À	Á	Â	Ë	
60	ä	b	c	d	e	f	g	h	i	j	k	l	m	n	o	
70	p	q	r	s	t	u	v	w	x	y	z	â	ä	å	ö	ù
80	0	1	2	3	4	5	6	7	8	9	%	±	Σ	Π		
90	↓	↑	⬆	⬇	⬈	⬉	⬊	⬋	⬌	⬍	⬎	⬏	⬐	⬑	⬒	
A0	@	£	¥	€	é	ù	i	ò	ƒ	°	0	°	°	°	°	
B0	Δ	Φ	Ψ	τ	λ	Ω	π	Υ	Σ	θ	ε	•	Α	α	Β	β
C0	Γ	Δ	Π	Υ	Λ	Ω	Π	Υ	Σ	θ	ε	•	Α	α	Β	β
D0	■	■	■	■	■	■	■	■	■	■	■	■	■	■	■	
E0	↓	↑	⬆	⬇	⬈	⬉	⬊	⬋	⬌	⬍	⬎	⬏	⬐	⬑	⬒	
F0	ö	ä	å	ä	ä	ä	ä	ä	ä	ä	ä	ä	ä	ä	ä	

Figure 4

To include the time \@ is used. The time occupies 8 characters hh:mm:ss

## 9.8 Settings Mode

The settings mode is entered by selecting 7 from the main menu. x must be entered to exit the settings mode.

Setting	Description	Command	Notes
<b>A</b>	Clock rate adjustment		
<b>C</b>	Display contrast		
<b>F</b>	Buzzer frequency		
<b>G</b>	Green led in auto switch brightness	Gn	n = 0 to 10
<b>L</b>	Clear the log	L0	Note this command will take a few seconds
<b>P</b>	Log output prefix	Ptext	text = up to 15 characters
<b>R</b>	Red led in hoot switch brightness	Rn	n = 0 to 10
<b>T</b>	Set the time	Thh:mm:ss	

A, C, F are set on manufacture and if there is a need to adjust these setting the user should contact [support@r-p-r.co.uk](mailto:support@r-p-r.co.uk)

## 9.9 AutoHoot Log

AutoHoot will record the time of the following events:

- Auto being switched on
- Hoot switch pressed
- Any hoots generated during a sequence

Times for the last 300 events are kept.

At the -> prompt type 8 and AutoHoot will respond with `output log`. If only a limited number of entries are required then the number of entries can be entered at this point. The following shows a request for 10 entries.

```
1 - select sequence
2 - enter sequence
3 - delete sequence
4 - copy sequence
5 - output sequence
6 - list all sequences
7 - settings mode
8 - output log
-> 8
output log 10

11:59:39,ah
11:59:38,ah
11:59:37,ah
11:59:07,ah
11:59:07,as
11:53:39,ah
11:53:39,as
15:53:46,ah
15:52:46,ah
15:49:46,ah

10 output
->
```

Entries output consist of three parts prefix, time and event type. The prefix can consist of up to 15 characters and could be used identify AutoHoot or race that the log relates to. For example, if the prefix is set to “Start boat” the log output would be:

```
output log 10

Start Boat 11:59:39,ah
Start Boat 11:59:38,ah
Start Boat 11:59:37,ah
Start Boat 11:59:07,ah
Start Boat 11:59:07,as
Start Boat 11:53:39,ah
Start Boat 11:53:39,as
Start Boat 15:53:46,ah
Start Boat 15:52:46,ah
Start Boat 15:49:46,ah

10 output
->
```

The prefix is set when in the settings mode see section 9.8

Event types are:

- ah – automatic hoot during a sequence
- as – auto switch switched on
- hs – hoot switch pressed

## 10 Backup Battery Warning

AutoHoot contains a CR2032 coin type battery to keep its clock running when power is disconnected.

Keep new and used coin type batteries out of the reach of children. Death or serious injury can occur if ingested. Seek immediate medical help if it is suspected that a battery has been ingested.

## 11 AUTOHOOT SPECIFICATION

Physical	Dimensions (including switches and cable gland)	168mm x 80mm x 76mm
	Enclosure dimensions (excluding switches and cable gland)	140mm x 80mm x 68mm
	Mounting holes	4 off 4.4mm dia., 120mm x 60mm
	Weight	335g
	Enclosure material	Polycarbonate, Light Gray RAL 7035
	Enclosure flammability rating	UL 746C 5V
	Cable Entry	Compression cable gland. With two part compression ring. Cable diameter 5 to 13 mm
Sequences	Pre-programmed sequences	Selectable by switch sequence on power up or via C-type USB cable
	Custom sequences	User programmable via standard C type USB Cable
Switches	Auto Switch	Stainless steel 2 position rotary switch with green illuminated arrow. IP67 rated
	Hoot Button	Stainless steel push-button switch with red illuminated ring. IP67 rated
Display	Type	High-contrast supertwist LCD
	Viewing angle	6 o'clock
	Viewing area	19mm x 38mm
Relay (Horn connection)	Rated Current	20A
	Endurance	>300,000 operations with resistive load at 20A
	Connection	Rising clamp style terminals (2.5mm <sup>2</sup> cable)
Timing	Accuracy	±1 ppm at 25 °C (ageing first year ±3 ppm max at 25 °C)
Communication	Protocol	Asynchronous serial, 8-bit data, no parity, 1 stop bit, Hardware flow control, 9600 baud.
	Connection	Via C-type USB
Power	Supply voltage	6.5 to 15 Vdc
	Current at 12Vdc	30 mA typical (with LEDs on, excluding horn current)
	Supply input protection	Polarity reversal protected. Internal replaceable fuse – 20A micro-blade automobile fuse
	Connection	Rising clamp style terminals (2.5mm <sup>2</sup> cable)
	Alternative power	5v via C-type USB connector. The relay/horn will not operate when powered via USB.
	Back up battery for time	CR2032
Environmental	Back up battery life	>5 years
	Operating Temperature Range	-20 °C to +70 °C
	Storage Temperature Range	-20 °C to +70 °C
	Ingress Protection	IP66
Guarantee	Compliance	UKCA, CE
	Period	2 years (return to manufacturer), refer to Appendix

The manufacturer reserves the right to amend the specification and therefore the information above may be subject to change. Please contact us for the latest information.

## APPENDICES

### A1 Guarantee

System components are warranted for a period of two years from the original date of purchase, against defective materials and workmanship. In the event that warranty service is required, please contact Richard Paul Russell Ltd.

This warranty is only valid if, when warranty service is required, a full description of the fault is provided and presented with the original invoice, and the serial number(s) on the component has not been defaced.

Richard Paul Russell Ltd's liability is limited to items of its own manufacture, and it does not accept liability for any loss resulting from the operation or interpretation of the results from this equipment.

This warranty covers none of the following:

- Periodic check ups, maintenance and repair or replacement of parts due to normal wear and tear.
- Cost relating to transport, removal, or installation of the component.
- Misuse, including failure to use the component for its normal purpose or incorrect installation.
- Damage caused by Lightning, Water, Fire, Acts of God, War, Public Disturbances, incorrect supply voltage or any other cause beyond the control of Richard Paul Russell Ltd.
- Units which have been repaired or units altered by a party other than Richard Paul Russell Ltd's employees or agents without prior written consent from Richard Paul Russell Ltd.

In no event shall Richard Paul Russell Ltd be liable under any circumstances for any direct, indirect or consequential damages, any financial loss or any lost data contained in any product (including any returned product), regardless of the cause of loss. Richard Paul Russell Ltd products are not warranted to operate without failure. Richard Paul Russell Ltd's products must not be used in life support systems or other application where failure could threaten injury or life.

The Customers statutory rights are not affected by this warranty. Unless there is national legislation to the contrary, the rights under this warranty are the customer's sole rights and Richard Paul Russell Ltd shall not be liable for indirect or consequential loss or damage to any other related equipment or material.

## A2 WEEE (Waste, Electrical and Electronic Equipment) Statement



The WEEE directive places an obligation on all EU-based manufacturers and importers to take-back electronic products at the end of their useful life. Richard Paul Russell Ltd accepts its responsibility to finance the cost of treatment and recovery of redundant WEEE in accordance with the specific WEEE recycling requirements.

This symbol on the product or on its packaging indicates that the product must NOT be disposed of with normal household waste. Instead, it is the end user's responsibility to dispose of their waste equipment by arranging to return it to a designated collection point for the recycling of WEEE. By separating and recycling waste equipment at the time of disposal, natural resources will be conserved and it will be ensured that the equipment is recycled in a manner that protects human health and the environment. For more information about where you can send your waste equipment for recycling, please contact your local council office or visit our website [www.r-p-r.co.uk](http://www.r-p-r.co.uk).

## A3 RoHS Statement

### (The Restriction of the Use of Certain Hazardous Substances in Electrical and Electronic Equipment Regulations 2006)



AutoHoot has been designed to comply with EU Directive 2002/95/EC on RoHS regulations that came into force on 1 July 2006. The unit is assembled from compliant components.

RoHS is often referred to as the lead-free directive, but it restricts the use of the following six substances:

- Lead (Pb)
- Mercury (Hg)
- Cadmium (Cd)
- Hexavalent chromium (Cr6+)
- Polybrominated biphenyls (PBB)
- Polybrominated diphenyl ether (PBDE)

PBB and PBDE are flame retardants used in some plastics.